

ADVERTISING Rate Card 2021



ABOUT THE SOUTHERN CROSS MAGAZINE

WHO WE ARE:

For a hundred years, *The Southern Cross* was a weekly newspaper with a high reputation worldwide. In an exciting relaunch to meet the needs of the time, it is now Southern Africa's Catholic MONTHLY MAGAZINE.

Established in 1920, *The Southern Cross* is published independently by the Catholic Newspaper & Publishing Company Ltd in Cape Town. The present editor-in-chief is Mr Günther Simmermacher, since 2001. The company's business manager is Ms Pamela Davids, since 1995. The digital editor of *The Southern Cross*' popular website is Ms Claire Allen, since 2010.

WHERE WE ARE:

Based in Cape Town, *The Southern Cross* is distributed by subscription, through sales by parishes and Catholic organisations, and in digital format.

WHAT YOU WILL FIND IN THE SOUTHERN CROSS MAGAZINE:

Faith-based articles relating to all things Catholic: faith and society, personalities, burning questions, travel, millennials, family, education, world class spiritual reflections, pull-out poster of a Saint of the Month, as well as fun stuff like the ever-popular Southern CrossWord, Word Search, Trivia Quiz, and so on.

CONTACT US

To book advertising and enquiries advertising@scross.co.za

MEDIA INFORMATION

Frequency	Monthly	Deadlines To guarantee placement of your ad, please book by the following dates (we will try our best to accommodate later bookings). MARCH ISSUE Bookings by January 5 Artwork by January 21 APRIL ISSUE Bookings by February 3 Artwork by February 19 MAY ISSUE Bookings by March 5 Artwork by March 24 JUNE ISSUE Bookings by April 7 Artwork by April 23 JULY ISSUE Bookings by May 7 Artwork by May 28
Print-run	7,500 plus digital subscribers	
Distribution	All South Africa	
Format	A4 Full Colour, Print & Digital	

ADVERTISING RATES

All rates include VAT. All ads are full colour. Inside cover spaces can be reserved at an extra 25% of the ad rate. Rates are valid for the editions of October 2020, November 2020, and December 2020.

Advert Size	(Height x Width mm)	Advert Rate
Double Page Spread	297mm x 420mm	R17,500
Full Page	297mm x 210mm	R13,000
Half Page	140mm x 210mm	R6,900
Quarter Page	135mm x 85mm	R3,320
110mm x 6 col	110mm x 210mm	R5,400
80mm x 6 col	80mm x 210mm	R3,900
110mm x 4 col	110mm x 119mm	R3,600
80mm x 4 col	80mm x 119mm	R2,620
40mm x 6 col	40mm x 210mm	R1,900
110mm x 2 col	110mm x 59mm	R1,800
80mm x 2 col	80mm x 59mm	R1,300
40mm x 4 col	40mm x 119mm	R1,300
40mm x 2 col	40mm x 59mm	R650

ADVERTISING SIZE SPECIFICATIONS

Double Page Spread:

297mm height x 420mm width

Size: 420 x 297 mm (Landscape)

Type Area: 10 mm inset

Gutter: 20 mm

Bleed: 3 mm added all round

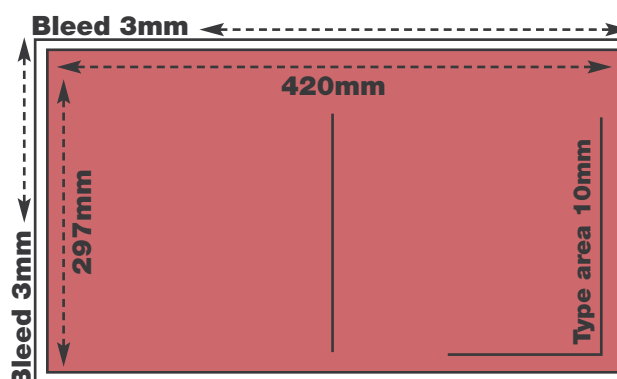

Full Page:

297mm height x 210mm width

Size: 420 x 297 mm (Portrait)

Type Area: 10 mm inset

Bleed: 3 mm added all round

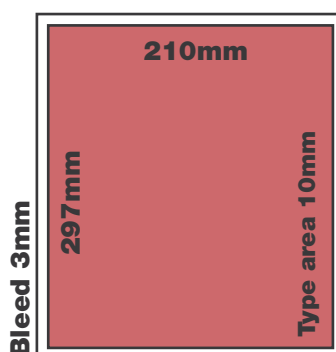

ADVERTISING SIZE SPECIFICATIONS.../CONT

Half Page:

140mm height
x 210mm width

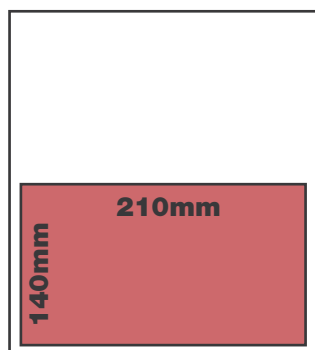

Type area 10mm
Bleed 3mm

Quarter Page:

135mm height
x 85mm width

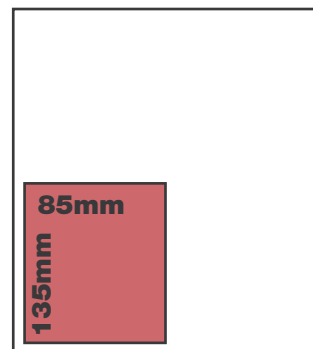

Type area 10mm
Bleed 3mm

11cm x 6 col:

110mm height
x 210mm width

11cm x 4 col:

110mm height
x 119mm width

11cm x 2 col:

110mm height
x 59mm width

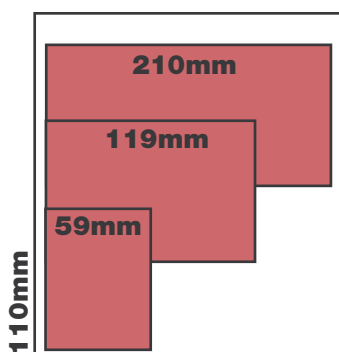

8cm x 6 col:

80mm height
x 210mm width

8cm x 4 col:

80mm height
x 119mm width

8cm x 2 col:

80mm height
x 59mm width

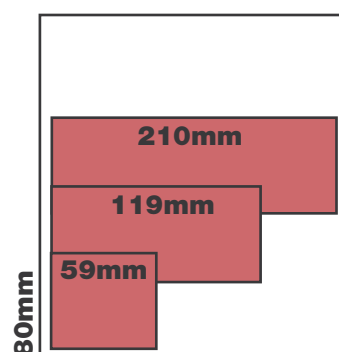

4cm x 6 col:

40mm height
x 210mm width

4cm x 4 col:

40mm height
x 119mm width

4cm x 2 col:

40mm height
x 59mm width

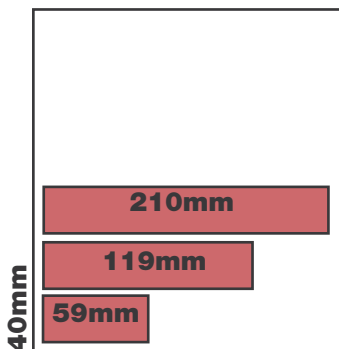

THE TECHNICAL STUFF

- All advertising material must be high resolution CMYK PDF, with all fonts embedded, or a high resolution jpg/png, minimum 300dpi.
- Bleed for F/P, H/P, Q/P and 6 col (210mm width ads): 3mm
- Type area: 10mm inset

BOOKING DETAILS

Please fill in the booking form at the end of this document. This form can be filled in electronically in Adobe Reader or printed and filled in. Booking forms must be emailed to advertising@scross.co.za

Please contact Pamela Davids at admin@scross.co.za for further queries.

WEBSITE ADVERTISING

Advertising space positions

Please see positions and numbering for website placement



Pope: Trust In God's Compassion, Tell Him Everything

By CNS - AUGUST 18, 2020



By Carol Glutz - Those who take time to understand Jesus will find he loves them and wants what is best for them, Pope Francis said.

Once people understand that Christ's heart is full of compassion and can bear people's sins, mistakes and pain, then it should be easier to find the courage "to bring our own story before God, before Jesus, to touch God's tenderness, Jesus' tenderness," he said Aug. 18 before the Angelus with visitors gathered in St. Peter's Square.



But she pleads, "Please, Lord, for even the dogs eat the scraps that fall from the table of their masters," to which Jesus replies, "great is your faith! Let it be done for you as you wish."

This woman could sense Jesus was good and would respond to the needs of any of God's creatures, Pope Francis said.

Her faith was great because she brought her personal "story," married as it was by pain and difficulty, and placed it at the Lord's feet asking him to heal those wounds and give them meaning, he said.

Everyone has his or her own "story" and it is not always pretty, he said. "Many times it is a difficult story, with a lot of

Average daily unique pageviews 1000, as of August 2020

Advertising space on scross.co.za

1. In-text banner appearing on every editorial page
2. Ad banner before content
3. & 4. Adverts placed in right and left sidebars (left sidebar larger size)
5. Ad banner after content
6. Ad banner full width bottom website

Advert space	Advert size	Advert rate (Cost per 1000 views)
In-text banner on every page	1400px x 200px	R70 CPM
Ad banner before content	1200px x 150/200px	R70 CPM
Adverts placed in right and left sidebars	Left: 250px x 375px Right: 150px x 375/250px	R70 CPM above fold R65 below fold
Ad banner after content	1200px x 150/200px	R60 CPM
Ad banner full-width	2400px x 250px	R60 CPM

Please contact advertising@scross.co.za for booking

BOOKING FORM

Ordered by: (please print) _____

Company name: _____

Address: _____

Telephone: (w) _____ (cell) _____

Email: _____

Date for insertion: _____ Repeat advert: Yes No

Special instruction: _____

Please tick the advert size you wish to book

Advert Size	(Height x Width mm)	Advert Rate	
Double Page Spread	297mm x 420mm	R17,500	<input type="checkbox"/>
Full Page	297mm x 210mm	R13,000	<input type="checkbox"/>
Half Page	140mm x 210mm	R6,900	<input type="checkbox"/>
Quarter Page	135mm x 85mm	R3,320	<input type="checkbox"/>
110mm x 6 col	110mm x 210mm	R5,400	<input type="checkbox"/>
80mm x 6 col	80mm x 210mm	R3,900	<input type="checkbox"/>
110mm x 4 col	110mm x 119mm	R3,600	<input type="checkbox"/>
80mm x 4 col	80mm x 119mm	R2,620	<input type="checkbox"/>
40mm x 6 col	40mm x 210mm	R1,900	<input type="checkbox"/>
110mm x 2 col	110mm x 59mm	R1,800	<input type="checkbox"/>
80mm x 2 col	80mm x 59mm	R1,300	<input type="checkbox"/>
40mm x 4 col	40mm x 119mm	R1,300	<input type="checkbox"/>
40mm x 2 col	40mm x 59mm	R650	<input type="checkbox"/>

Account to (if not the same as above): _____

Address: _____

Signature _____

BOOKING FORM SCROSS.CO.ZA WEBSITE

Ordered by: (please print) _____

Company name: _____

Address: _____

Telephone: (w) _____ (cell) _____

Email: _____

Date for insertion: (From) _____ (To) _____

Special instruction: _____

Please tick the advert size you wish to book

Advert space	Advert size (wxh)	Advert rate (Cost per 1000 views)	
In-text banner on every page	1400px x 200px	R70 CPM	<input type="checkbox"/>
Ad banner before content	1200px x 150/200px	R70 CPM	<input type="checkbox"/>
Adverts right sidebar	150px x 375/250px	R70 CPM above fold R65 below fold	<input type="checkbox"/> <input type="checkbox"/>
Adverts left sidebar	Left: 250px x 375px	R70 CPM above fold R65 below fold	<input type="checkbox"/> <input type="checkbox"/>
Ad banner after content	1200px x 150/200px	R60 CPM	<input type="checkbox"/>
Ad banner full-width	2400px x 250px	R60 CPM	<input type="checkbox"/>

Account to (if not the same as above): _____

Address: _____

Signature _____

Please email booking form to advertising@scross.co.za for booking