

ADVERTISING

# Rate Card 2023

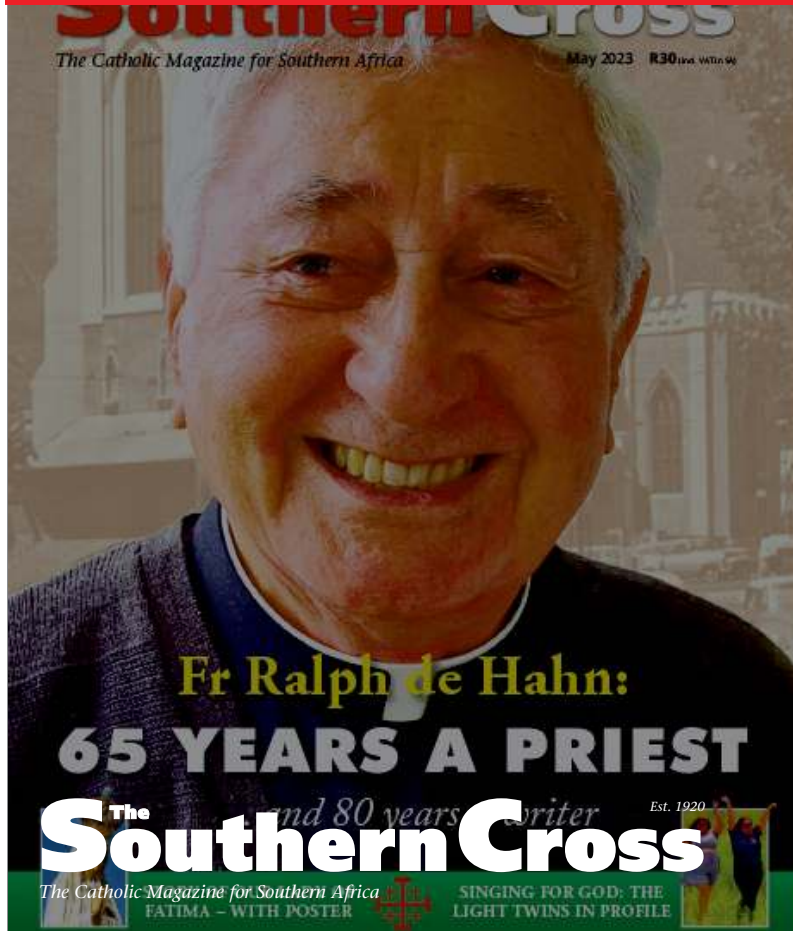

# ABOUT THE SOUTHERN CROSS MAGAZINE

## WHO WE ARE:

For a hundred years, *The Southern Cross* was a weekly newspaper with a high reputation worldwide. In an exciting relaunch to meet the needs of the time, it is now Southern Africa's Catholic MONTHLY MAGAZINE.

Established in 1920, *The Southern Cross* is published independently by the Catholic Newspaper & Publishing Company Ltd in Cape Town. The present editor-in-chief is Mr Günther Simmermacher, since 2001. The company's business manager is Ms Pamela Davids, since 1995. The digital editor of *The Southern Cross*' popular website is Ms Claire Allen, since 2010.

## WHERE WE ARE:

Based in Cape Town, *The Southern Cross* is distributed by subscription, through sales by parishes and Catholic organisations, and in digital format.

## WHAT YOU WILL FIND IN THE SOUTHERN CROSS MAGAZINE:

Faith-based articles relating to all things Catholic: faith and society, personalities, burning questions, travel, millennials, family, education, world class spiritual reflections, pull-out poster of a Saint of the Month, as well as fun stuff like the ever-popular Southern CrossWord, Word Search, Trivia Quiz, and so on.

## CONTACT US

To book advertising and enquiries [advertising@scross.co.za](mailto:advertising@scross.co.za)

# MEDIA INFORMATION

<b>Frequency</b>	Monthly
<b>Print-run</b>	7,500 plus digital subscribers
<b>Distribution</b>	All South Africa
<b>Format</b>	A4 Full Colour, Print & Digital

**The Catholic Magazine for Southern Africa**



# ADVERTISING RATES

All rates include VAT. All ads are full colour. Inside cover spaces can be reserved at an extra 25% of the ad rate.

Advert Size	(Height x Width mm)	Advert Rate
Double Page Spread	297mm x 420mm	<b>R17,500</b>
Full Page	297mm x 210mm	<b>R13,000</b>
Half Page	140mm x 210mm	<b>R6,900</b>
Quarter Page	135mm x 85mm	<b>R3,320</b>
110mm x 6 col	110mm x 210mm	<b>R5,400</b>
80mm x 6 col	80mm x 210mm	<b>R3,900</b>
110mm x 4 col	110mm x 119mm	<b>R3,600</b>
80mm x 4 col	80mm x 119mm	<b>R2,620</b>
40mm x 6 col	40mm x 210mm	<b>R1,900</b>
110mm x 2 col	110mm x 59mm	<b>R1,800</b>
80mm x 2 col	80mm x 59mm	<b>R1,300</b>
40mm x 4 col	40mm x 119mm	<b>R1,300</b>
40mm x 2 col	40mm x 59mm	<b>R650</b>

# ADVERTISING SIZE SPECIFICATIONS

## Double Page Spread:

297mm height x 420mm width

Size: 420 x 297 mm (Landscape)

Type Area: 10 mm inset

Gutter: 20 mm

Bleed: 3 mm added all round

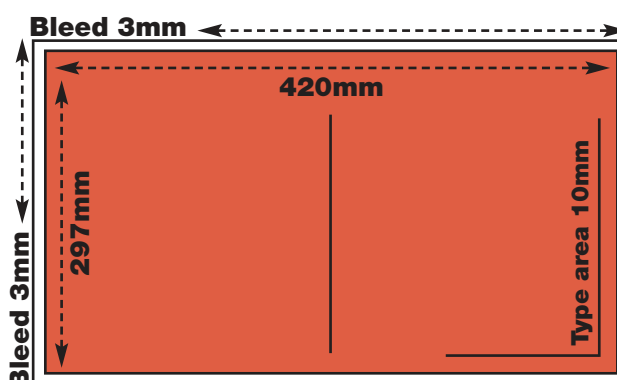

## Full Page:

297mm height x 210mm width

Size: 210 x 297 mm (Portrait)

Type Area: 10 mm inset

Bleed: 3 mm added all round

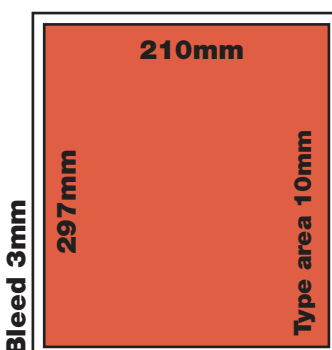

# ADVERTISING SIZE SPECIFICATIONS.../CONT

## Half Page:

140mm height  
x 210mm width

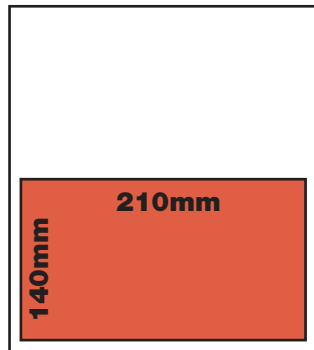

Type area 10mm  
Bleed 3mm

## Quarter Page:

135mm height  
x 85mm width

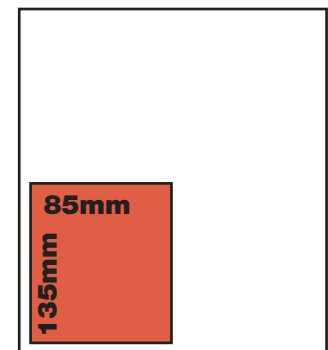

Type area 10mm  
Bleed 3mm

## 11cm x 6 col:

110mm height  
x 210mm width

## 11cm x 4 col:

110mm height  
x 119mm width

## 11cm x 2 col:

110mm height  
x 59mm width

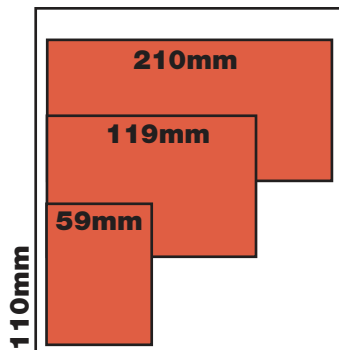

## 8cm x 6 col:

80mm height  
x 210mm width

## 8cm x 4 col:

80mm height  
x 119mm width

## 8cm x 2 col:

80mm height  
x 59mm width

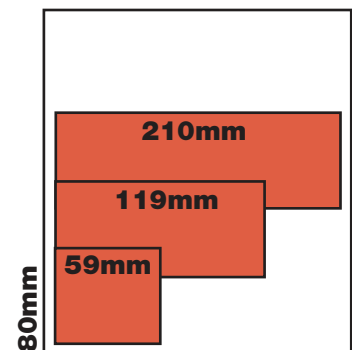

## 4cm x 6 col:

40mm height  
x 210mm width

## 4cm x 4 col:

40mm height  
x 119mm width

## 4cm x 2 col:

40mm height  
x 59mm width

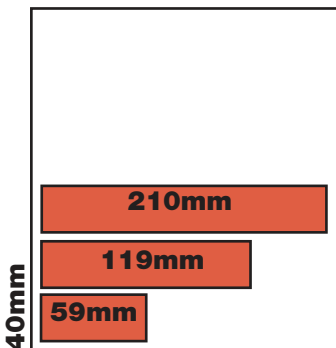

## THE TECHNICAL STUFF

- All advertising material must be high resolution CMYK PDF, with all fonts embedded, or a high resolution jpg/png, minimum 300dpi.
- Bleed for F/P, H/P, Q/P and 6 col (210mm width ads): 3mm
- Type area: 10mm inset

# BOOKING DETAILS

Please fill in the booking form at the end of this document. This form can be filled in electronically in Adobe Reader or printed and filled in. Booking forms must be emailed to [advertising@scross.co.za](mailto:advertising@scross.co.za)

Please contact [advertising@scross.co.za](mailto:advertising@scross.co.za) for further queries.

# WEBSITE ADVERTISING

## Advertising space positions

Please see positions and numbering for website placement



## Pope: Trust In God's Compassion, Tell Him Everything



By Carol Glatz - Those who take time to understand Jesus will find he loves them and wants what is best for them, Pope Francis said. Once people understand that Christ's heart is full of compassion and can bear people's sins, mistakes and pain, then it should be easier to find the courage "to bring our own painful story before God, before Jesus, to touch God's tenderness, Jesus' tenderness," he said Aug. 16 before the Angelus with visitors gathered in St. Peter's Square.



But she pleads, "Please, Lord, for even the dogs eat the scraps that fall from the table of their masters," to which Jesus replies, "great is your faith! Let it be done for you as you wish." This woman could sense Jesus was good and would respond to the needs of any of God's creatures, Pope Francis said. Her faith was great because she brought her personal "story," marred as it was by pain and difficulty, and placed it at the Lord's feet asking him to heal those wounds and give them meaning, he said.

Everyone has his or her own "story" and it is not always pretty, he said. "Many times it is a difficult story, with a lot of

## Advertising space on scross.co.za

1. In-text banner appearing on every editorial page
2. Ad banner before content
3. & 4. Adverts placed in right and left sidebars (left sidebar larger size)
5. Ad banner after content
6. Ad banner full width bottom website

Advert space	Advert size	Advert rate
In-text banner on every page	1400px x 200px	<b>R65 per day</b>
Ad banner before content	1200px x 150/200px	<b>R65 per day</b>
Adverts placed in right and left sidebars	Left: 250px x 375px Right: 150px x 375/250px	<b>R65 per day</b>
Ad banner after content	1200px x 150/200px	<b>R65 per day</b>
Ad banner full-width	2400px x 250px	<b>R65 per day</b>

Please contact [advertising@scross.co.za](mailto:advertising@scross.co.za) for booking